

 READ THIS PRODUCT INSERT THOROUGHLY BEFORE USE

FIG. 1 FORNISEE® SYSTEM

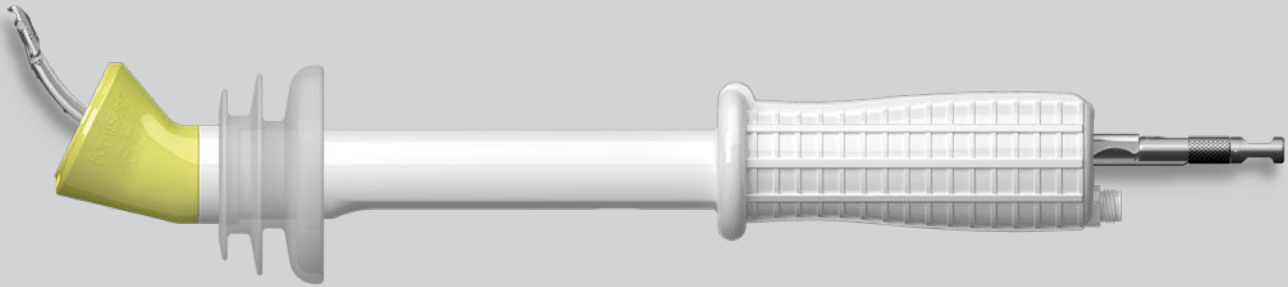

DESCRIPTION

The LSI SOLUTIONS® FORNISEE® SYSTEM provides a uterine manipulator technology for use in laparoscopic surgery, including Laparoscopically Assisted Vaginal Hysterectomy (LAVH), Total Laparoscopic Hysterectomy (TLH) and Laparoscopic Supracervical Hysterectomy (LSH) procedures. FS® SOUNDS and FS® DEVICES are designed to allow for anatomical manipulation of both retroverted and anteverted uteri. The FORNISEE® SYSTEM includes a custom distal cup that can displace the cervix away from the ureters, help define and create the bladder flap and highlight the colpotomy incision landmarks.

FIG. 2 FORNISEE® SYSTEM DEVICES

INDICATIONS

The FORNISEE® SYSTEM is intended for use as a uterine manipulator in laparoscopic hysterectomy surgical procedures to identify the vaginal fornices and manipulate the uterus.

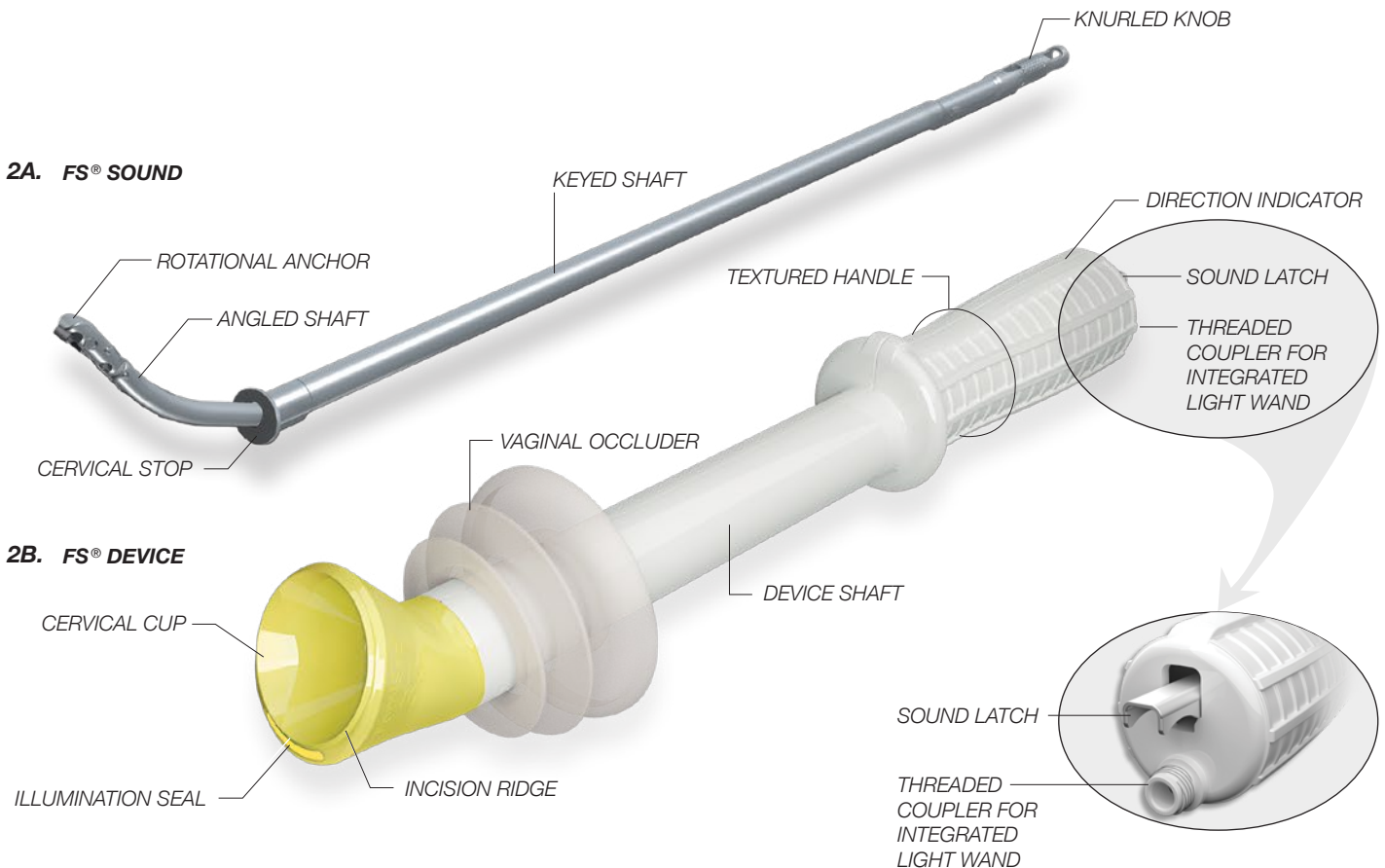

PRESCRIPTION USE

Federal (U.S.A.) law restricts these devices to sale, distribution and use by, or on, the order of a physician.

CONTRAINDICATIONS

- Minimally invasive surgical procedures should only be performed by physicians having adequate training and familiarity with endoscopic techniques. In addition, medical literature should be consulted relative to techniques, complications and hazards prior to the performance of minimally invasive procedures.
- The *FORNISEE*® SYSTEM devices are not intended to be used with components from any other company's uterine manipulators or alternative device components.
- Do not use this technology under conditions in which excessive tissue compression or tension can lead to tissue damage. For example, do not use the *FS*® SOUND or *FS*® DEVICE through an excessively narrow, restrictive or deformed vaginal canal or pelvic floor, which could significantly impair smooth passage and safe use of these devices.
- The *FORNISEE*® SYSTEM should not be used in patients who are suspected of being pregnant or who are pregnant, who have an intrauterine device in place, who are planning gamete intrafallopian transfer, or in patients for whom the surgeon deems it inadvisable or finds it difficult to insert the angled tip of the *FS*® SOUND or the distal cup of the *FS*® DEVICE.

WARNINGS

- Read and become familiar with all instructions, warnings, and cautions before using this product. Improper use of this system or any intrauterine instrument can result in perforation of the uterine wall, injury to the pelvic floor or internal structures and subsequent bleeding.
- The *FORNISEE*® SYSTEM is designed for use in patients in whom a uterus is present and the intraoperative positioning of the uterus, fallopian tubes and ovaries are desirable.
- Users should be familiar with surgical procedures and techniques involving uterine manipulation before employing the *FORNISEE*® SYSTEM in patients.
- Acceptable surgical practice must be followed with respect to transvaginal uterus access and positioning.
- The *FORNISEE*® SYSTEM is indicated for use for transvaginal uterine manipulation during gynecologic surgical procedures. Applications other than these indications damage the device making it unsuitable for continued use.
- When performing colpotomy do not use laser with this product.
- Do not use plastic distal cervical cup as a backstop for the colpotomy incision; create colpotomy incision inside of incision ridge, which is inside of the illumination seal. Thermal cutting against the distal *FS*® DEVICE may melt or damage the cervical cup and illumination seal.
- Do not resterilize the *FS*® DEVICE. The performance of the *FS*® DEVICE after cleaning or other reprocessing has not been verified and is not supported by LSI SOLUTIONS®.
- Discard opened, unused, expired or damaged devices or devices in damaged primary packaging.
- STERILE: The *FS* Device is provided STERILE. Remove the device in an aseptic manner. LSI SOLUTIONS® cannot guarantee sterility if the package seal is compromised or if the package is improperly opened.
- NON-STERILE:** *FS*® SOUNDS are provided NON-STERILE. Each *FS*® SOUND must be cleaned and sterilized before use. See reprocessing instructions below.
- Do not use the LSI *FS*® SOUND if it cannot be reprocessed according to the validated procedures listed below.
- Do not use a damaged or defective *FS*® SOUND. Carefully inspect the *FS*® SOUND before surgical use and before sterilization based on the procedures listed below.
- Do not use the integrated *FS*® LIGHT WAND prior to initiation of the colpotomy incision.
- Do not connect the *FS*® LIGHT WAND threaded coupler to a fiber cable or turn on light source until the vaginal forniceal dissection is about to commence.
- Do not use illumination with Xenon light sources that have power greater than 300W.
- Do not use fiber bundles (light cables) with fiber diameter of greater than 5mm with the *FS*® LIGHT WAND, to reduce the risk of tissue injury or burns.
- Use the minimum light output necessary to transilluminate tissue structures. With the *FS*® LIGHT WAND connected to a light source at high output, the transparent seal area of the *FS*® DEVICE may exceed 41°C due to the light energy emitted.
- Only use the *FS*® LIGHT WAND illumination during dissection of vaginal cuff. When the *FS*® LIGHT WAND is connected to the light source, avoid touching the tip of the *FS*® DEVICE with patient tissue, flammable, or combustible materials, as burns or permanent damage may result.
- Do not place the fiber cable coupler directly on patient or flammable material. The connection between the *FS*® LIGHT WAND and the light source can become very hot. Be careful when handling.
- Turn off the light source and remove the optical cable from the *FS*® DEVICE when the *FS*® DEVICE is removed from the patient.
- The *FS*® LIGHT WAND should NOT be used with light sources that do not have an IR filter, or that have had the IR filter removed.

PRECAUTIONS

- Minimally invasive instruments may vary from manufacturer to manufacturer. Before endoscopic instruments and accessories from different manufacturers are employed together in a procedure, verify compatibility and ensure electrical isolation or grounding are not compromised.
- Care must be taken when inserting this or any uterine manipulation device to avoid advancing the device incorrectly (e.g., too far or too quickly). Device insertion should be easy, smooth and controlled to minimize the risks of trauma to the patient or damage to the device.
- If uterine specimen is not easily delivered through the vaginal canal, release the rotational anchor and remove the *FORNISEE*® SYSTEM from the patient, then remove the uterine specimen using alternative techniques.
- Always assure insufflation, camera position and device usage are optimized and the uterus is viewed under direct visualization.
- Avoid damage to the *FS*® DEVICE or *FS*® SOUND from the direct application of surgical instruments, like forceps, needle holders, clamps, etc.
- Use of this technology requires appropriate laparoscopic surgical techniques for minimally invasive gynecologic surgery based on the surgical circumstances and the experience of the surgeon.
- Always confirm that illumination components are clear of any debris, discoloration or damage that may impede transmission of illumination.

CLEANING & STERILE PROCESSING

After completion of hysterectomy, remove the *FS*® LIGHT GUIDE from the *FS*® DEVICE threaded coupler, then remove the *FS*® DEVICE from the *FS*® SOUND. Discard the *FS*® DEVICE according to local biological hazardous material requirements. DO NOT ATTEMPT TO RE-USE THE *FS*® DEVICE.

See detailed processing instructions on PAGE 6.

WARRANTY

There is no defined maximum number of surgical uses for the *FS*® SOUND. The end of its service lifetime is determined by details of its surgical use and how it is handled between uses. Careful inspection and functional test of the instrument can be used to determine the end of its serviceable life.

MANUFACTURED UNDER ONE OR MORE OF THE FOLLOWING RELATED PATENTS:

U.S. Patent No. 8,603,105. Additional Patents pending.

PREPARATION & PLACEMENT

FIG. 3 *Expose and sound uterus in a routine fashion to determine uterine depth and direction.
Dilate cervix to accommodate 5mm diameter of FS® SOUND angled shaft.

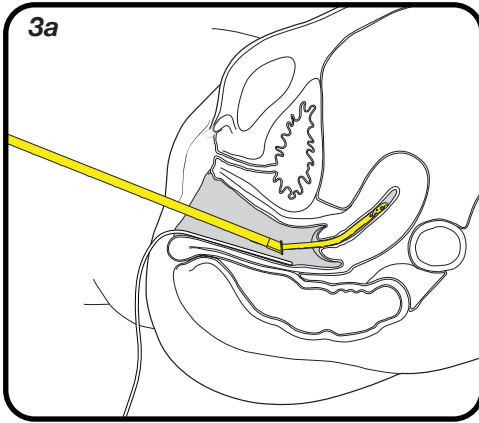

After routine uterine sounding, grasp anterior lip of cervix with single-toothed tenaculum if desired. Use sterile lubricant to lubricate FS® SOUND. Insert FS® SOUND tip through cervical os with "UP" oriented towards ceiling.

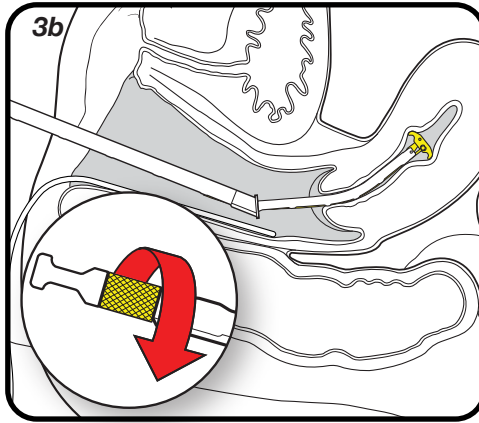

Rotate knurled knob clockwise at proximal end of FS® SOUND to deploy anchor.

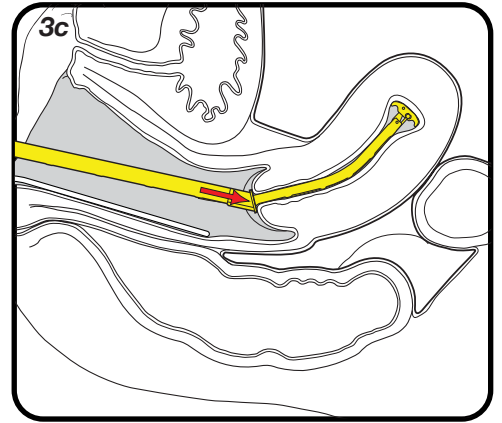

Advance FS® SOUND into uterine cavity until cervical stop engages external os. Ensure FS® SOUND is secure. Remove tenaculum from cervix if necessary. Stabilize FS® SOUND to prevent accidental dislodging.

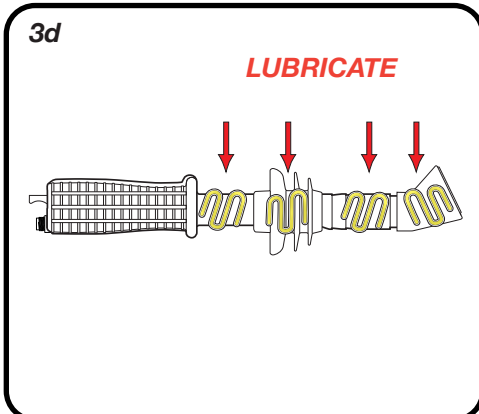

Select appropriate sized FS® DEVICE. Examine sterile pouch for damage. Open package, remove FS® DEVICE using appropriate techniques and lubricate shaft, vaginal occluder and distal cup.

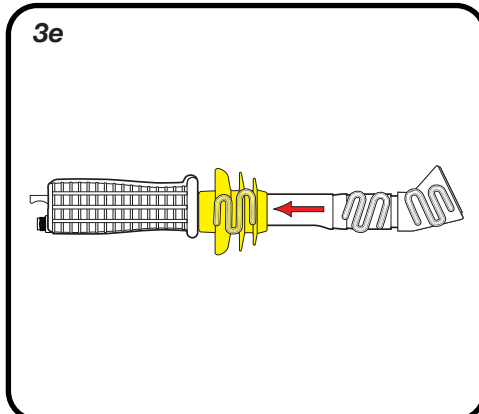

Slide vaginal occluder back to handle.

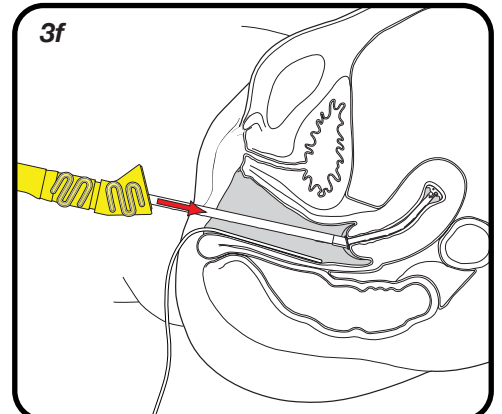

Insert FS® DEVICE over proximal FS® SOUND.

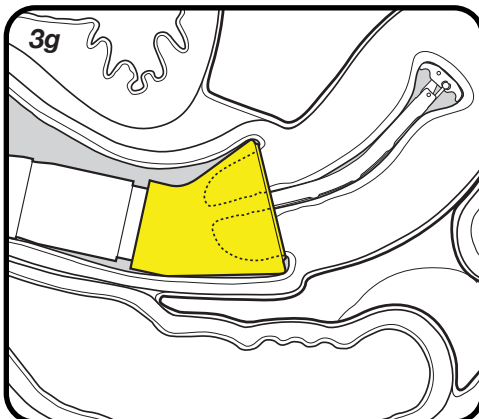

Slide distal cervical cup over cervix.

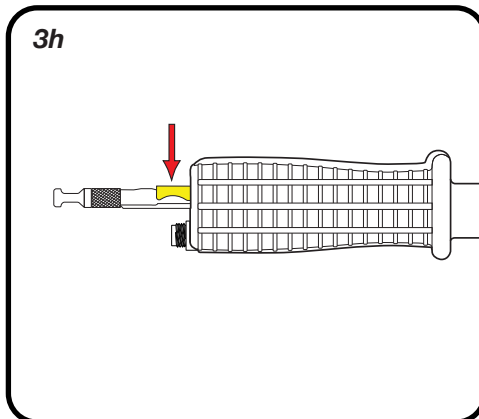

Ensure latch is engaged and that both devices are held securely.

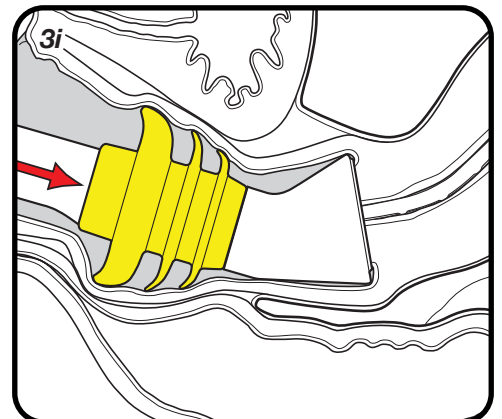

Advance vaginal occluder into vaginal vault.

INTRA-OPERATIVE USE

FIG. 4

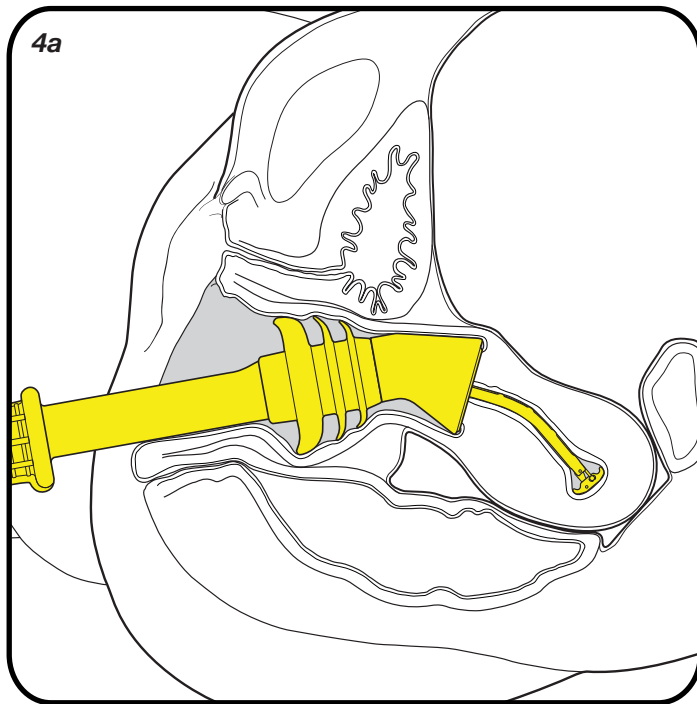

Retroflexion for anterior colpotomy and bladder flap development.

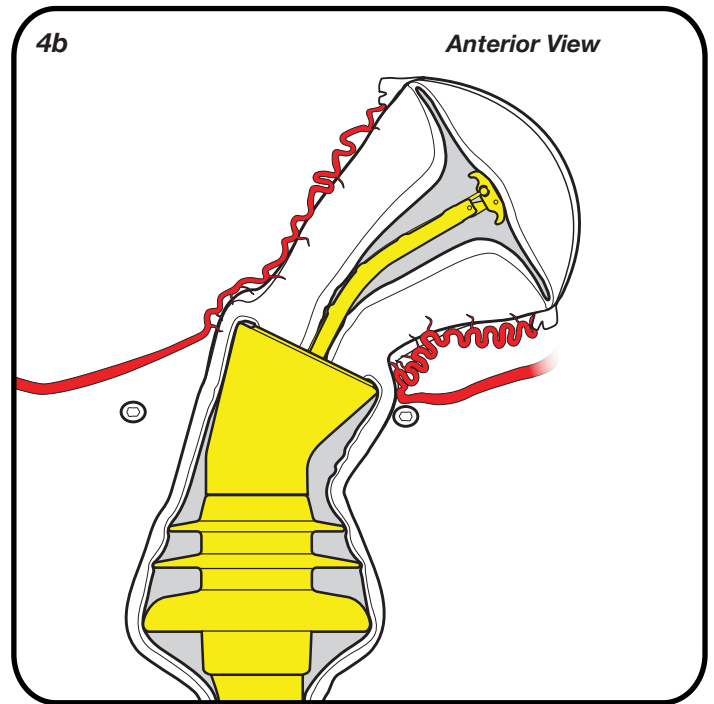

Left lateral displacement for right lateral colpotomy and right uterine artery dissection.

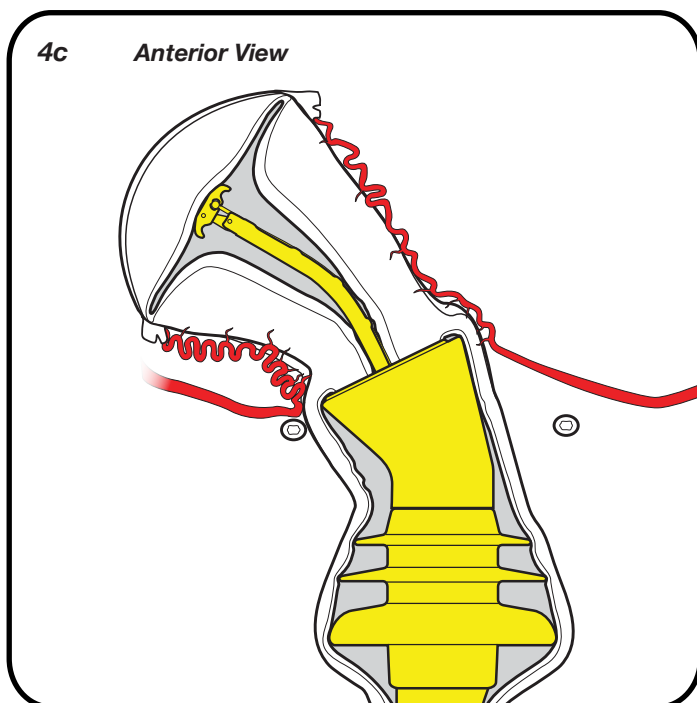

Right lateral displacement for left lateral colpotomy and left uterine artery dissection.

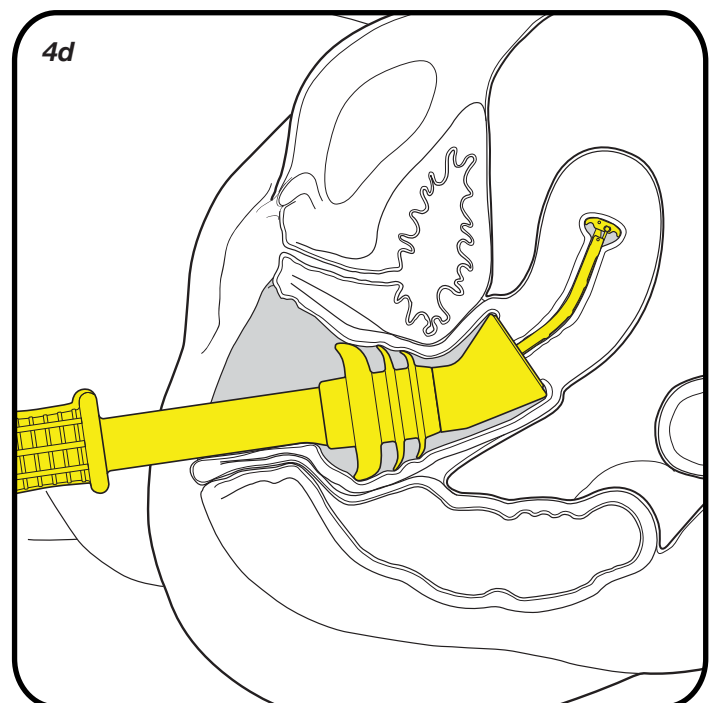

Anteflexion for posterior colpotomy dissection.

OPTIONAL USE OF FS® LIGHT WAND

FIG. 5

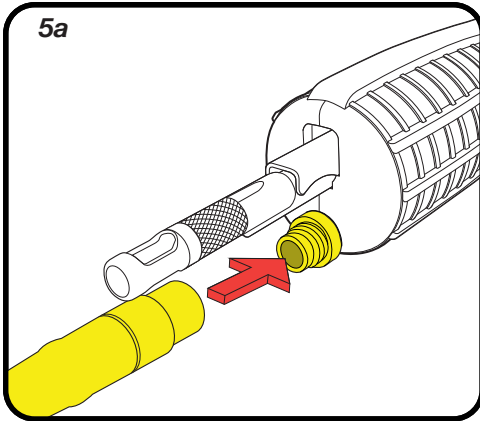

If illumination is desired, slide the FS® LIGHT GUIDE over the threaded coupler for the integrated light wand. Ensure proper alignment of FS® LIGHT GUIDE with threaded coupler.

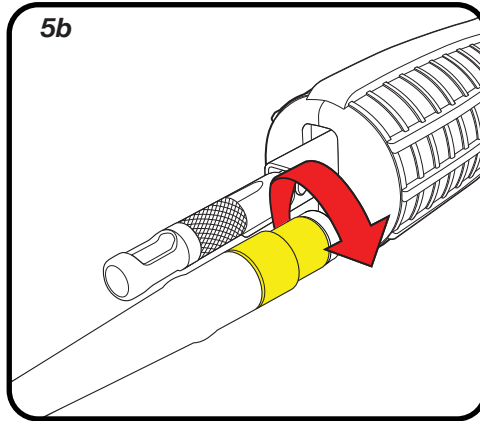

Rotate the metal ring on the FS® LIGHT GUIDE clockwise until it is fully and tightly seated on the shoulder of the FS® DEVICE.

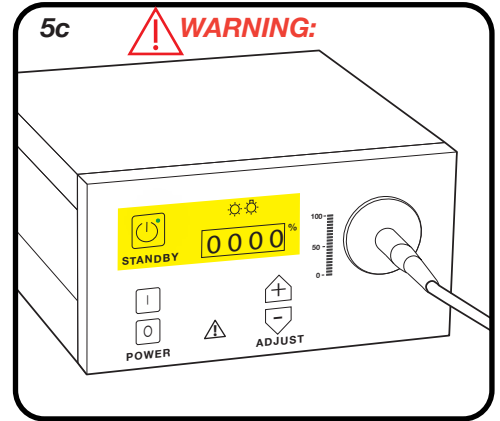

Keep the illumination off or on standby except during colpotomy dissection. Use light only when needed and set to lowest viewable level. See WARNINGS pertaining to FS® LIGHT WAND illumination.

REMOVAL AND CLEAN UP

FIG. 6

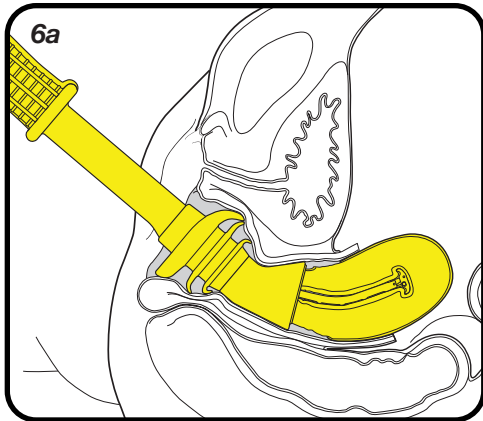

After hysterectomy has been completed, pull uterus back toward vagina into open vaginal cuff.

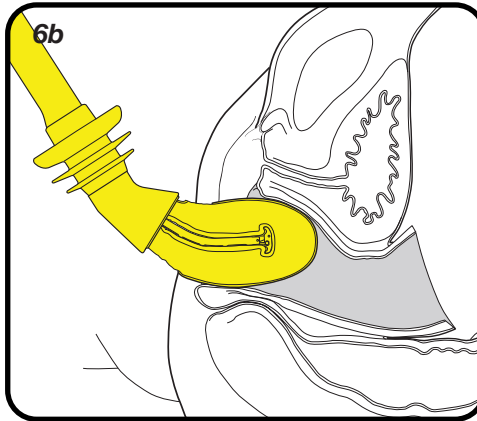

Deliver uterus and devices out through vaginal canal. Do not use excessive force.

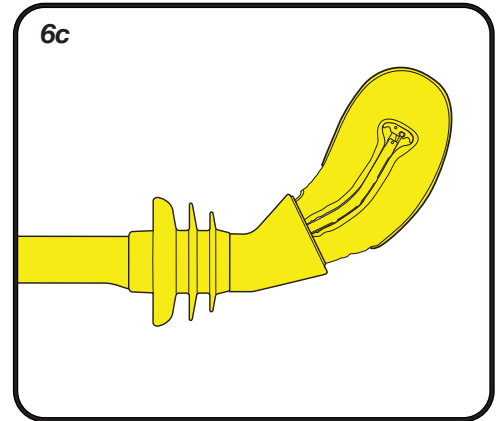

Remove specimen and FORNISEE® SYSTEM from surgical field.

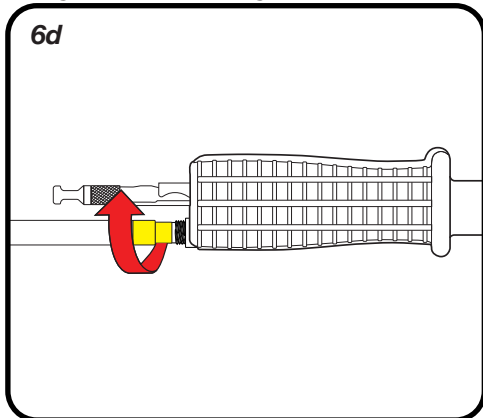

Rotate the metal ring on the FS® LIGHT GUIDE counter clockwise until it releases from the threaded coupler for the integrated light wand.

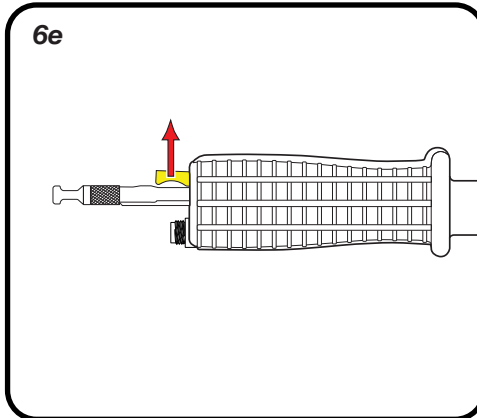

Lift latch to release FS® SOUND. Remove FS® DEVICE.

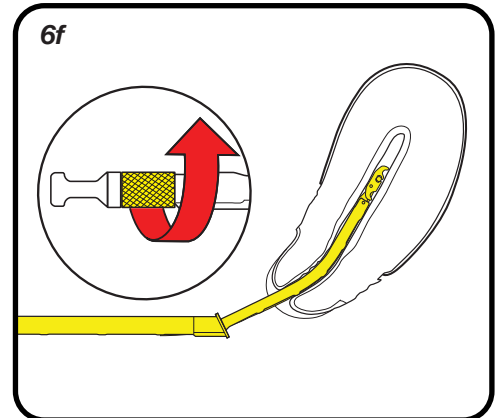

Rotate FS® SOUND knurled knob counter clockwise to retract anchor. Remove FS® SOUND.

FS® SOUND CLEANING & STERILIZATION

FS® SOUND CLEANING INSTRUCTIONS:

Disassemble and clean device immediately after use.

1. Disassemble and discard the disposable FS® DEVICE if still assembled with FS® SOUND.
2. Soak the device(s) in an enzymatic detergent solution for 5-10 minutes. Refer to the detergent manufacturer's instructions.
3. Rinse device with warm water for a minimum of 1 minute with rotational anchor in each position; deployed and retracted. Flush all channels with a syringe.
4. Thoroughly scrub/brush the device's exterior surfaces, working drive wire channel and cervical anchor area in deployed AND retracted position, using appropriately sized brushes in detergent/enzymatic solution.
 - a. Use a 4mm diameter nylon brush for inside the knurled knob at proximal end. Rotate the knurled knob while cleaning with brush.
 - b. Use a 3mm diameter nylon brush to clean the distal rotational anchor while in the deployed position. The wire size of the brush should not exceed 1mm in diameter.
5. If available, place device in ultrasonic bath of appropriate solution, with drive wire channel facing bottom of tank and rotational anchor in deployed position. Activate ultrasonic cleaning bath for a minimum of 5 minutes.
6. Rinse device in warm water for a minimum of 1 minute. Flush all channels with a syringe.
7. Carefully inspect the device to assure that all visible soil has been removed. Repeat cleaning process if soil is detected.

LUBRICATION:

Apply instrument lubricant mixed to manufacturer's recommendations to prolong instrument life by submerging the entire device in the lubricant for a minimum of 30 seconds. If the hospital washer-disinfector has a lubrication cycle this can be used instead of manual lubrication.

NOTE: LSI has validated the use of Micro-Scientific® MicroLube™ C / Weiman® Instrument Lubricant on this device. Other instrument lubricant brands have not been tested and performance and results cannot be guaranteed.

INSPECTION:

Check that the rotational anchor of the FS® SOUND deploys and retracts fully. Check for loose parts. Make sure all exterior surfaces are free of dents, burrs, corrosion, or jagged edges. Do not use if device is bent or damaged. If the FS® SOUND has reached the end of its serviceable life, the device must be disposed of consistent with standard, accepted medical device disposal procedures.

FS® SOUND STERILIZATION INSTRUCTIONS:

The device must be properly cleaned and dried prior to sterilization.

STEAM AUTOCLAVE STERILIZATION:

1. Rotate the knurled knob to place the rotational anchor into the deployed position.
2. The FS® SOUND can be sterilized by steam autoclave with the following parameters (refer to AAMI TIR12): Double wrap the FS® SOUND(s) in sterilization wrap.
3. Perform sterilization cycle with the following parameters:
 - Pre-vacuum cycle: 132°C, Full exposure time at 4 minutes
 - Drying time: 30 minutes

IMMEDIATE USE/ "FLASH" STEAM STERILIZATION:

1. Rotate the knurled knob to place the rotational anchor in the deployed position.
2. Do NOT wrap FS® SOUND in sterilization wrap. Position devices directly into autoclave to allow direct steam exposure to all surfaces.
3. Perform Immediate Use Sterilization with the following parameters:
 - Pre-vacuum cycle: 132°C, Full exposure time at 4 minutes
 - Drying Time: N/A

Device(s) processed by Immediate Use Sterilization should be transferred immediately, using aseptic technique, from the sterilizer to the point of use. Refer to ANSI/AAMI ST79 Comprehensive Guide to Steam Sterilization and Sterility Assurance in Health Care Facilities.

HYDROGEN PEROXIDE GAS PLASMA STERILIZATION (USE ONLY WITH STERRAD NX SYSTEM)

1. Rotate the knurled knob to place the rotational anchor into the deployed position.
2. Observe all safety information in the Sterrad® User's Guide.
3. Assure device is completely dry.
4. Prepare the device(s) for sterilization according to the Sterrad® User's Guide and load into unit.
5. Execute the Advanced sterilization cycle per Sterrad® User's Guide.

During storage, make sure that the instruments remain in a sterile condition and are ready for their next use.

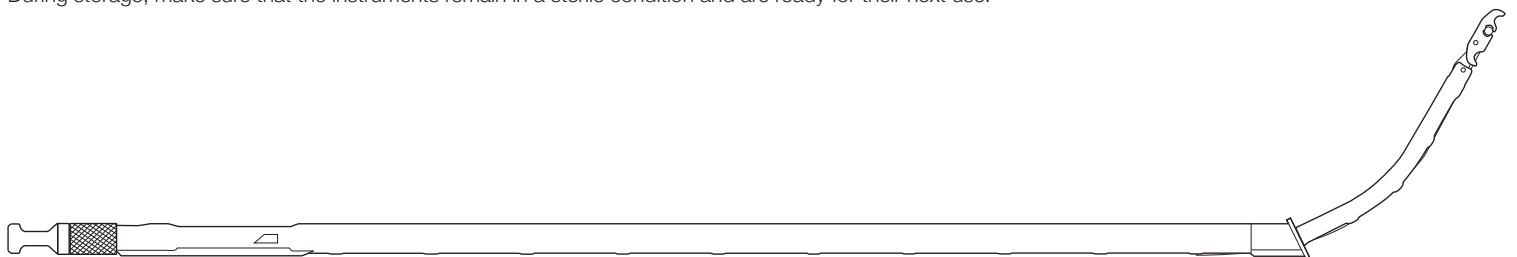

FORNISEE® SYSTEM

FIG. 7 FS® DEVICE INSTALL OVER FS® SOUND

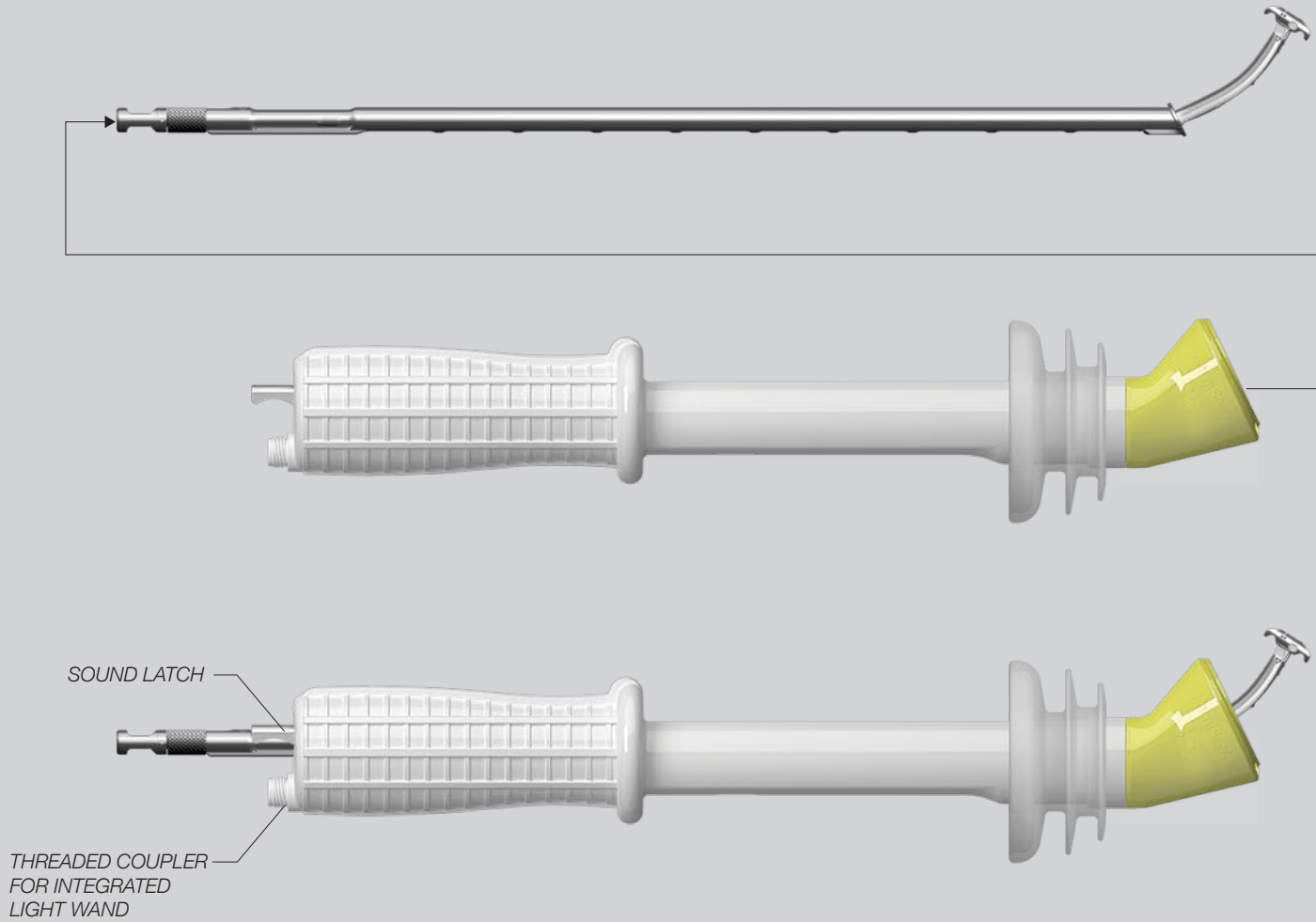
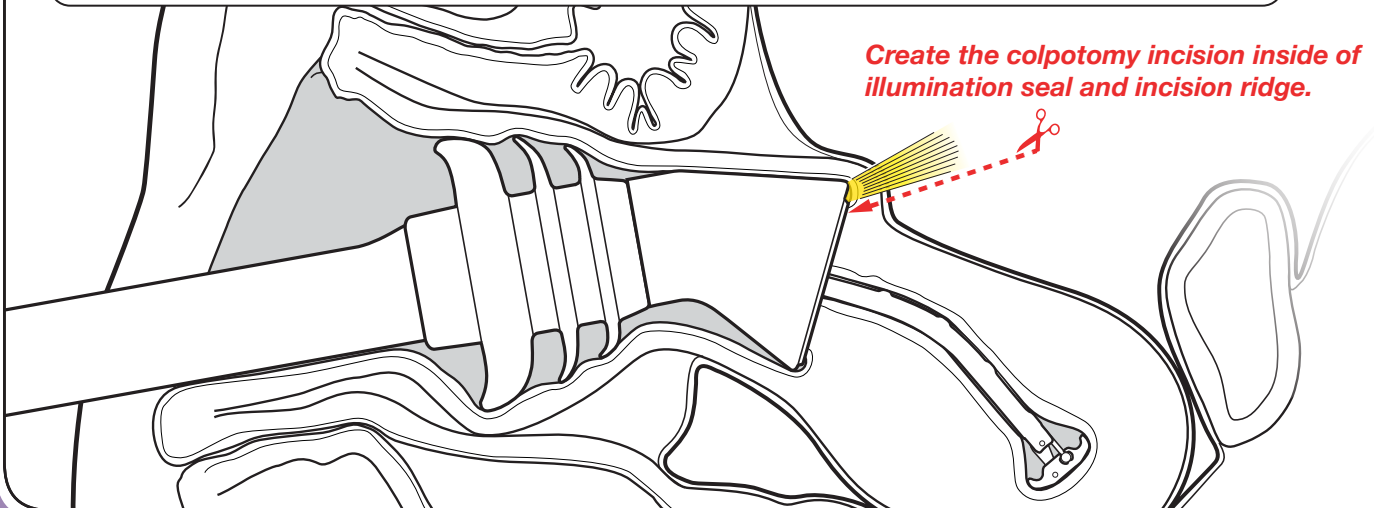

FIG. 8 TRANSILLUMINATION PERIPHERAL TO THE COLPOTOMY INCISION SITE



FS® SOUNDS			SUPPLIED: NONSTERILE	
SIZE	QTY.	REORDER	PRODUCT	DESCRIPTION
6cm	1	110056	6cm FS® SOUND - SINGLE	1 Reusable Device
8cm	1	110058	8cm FS® SOUND - SINGLE	1 Reusable Device
10cm	1	110105	10cm FS® SOUND - SINGLE	1 Reusable Device
12cm	1	110106	12cm FS® SOUND - SINGLE	1 Reusable Device
6cm, 8cm, 10cm, 12cm	1,1,1,1	110112	6cm,8cm,10cm,12cm FS® SOUNDS - SET OF 4	4 Reusable Devices

FS® DEVICES			SUPPLIED: STERILE, SINGLE PATIENT USE	
SIZE	QTY.	REORDER	PRODUCT	DESCRIPTION
30mm	6	110030	FS-30 DEVICE - (30mm Cervical Cup)	Box of 6 Single Patient Use Devices
35mm	6	110035	FS-35 DEVICE - (35mm Cervical Cup)	Box of 6 Single Patient Use Devices
40mm	6	110040	FS-40 DEVICE - (40mm Cervical Cup)	Box of 6 Single Patient Use Devices
30mm, 35mm, 40mm	2,2,2	110029	FS-30 DEVICE - (30mm Cervical Cup) FS-35 DEVICE - (35mm Cervical Cup) FS-40 DEVICE - (40mm Cervical Cup)	Combo Box of 6 Single Patient Use Devices (2 of each size)

FS® LIGHT GUIDE*			SUPPLIED: NONSTERILE	
SIZE	QTY.	REORDER	PRODUCT	DESCRIPTION
7.5ft x 5mm	1	100025	FS® LIGHT GUIDE - SINGLE	1 Reusable Fiberoptic Cable

* Light guide manufactured by Fiberoptics Technology, Inc., 1 Quassett Road, Pomfret, CT 06258, USA. +1.800.433.5248

LSI SOLUTIONS®

Patents: www.lsisolutions.com/patents

The LSI logo, LSI SOLUTIONS, FS, ForniSee and Perfect Performance Policy are trademarks and registered trademarks of LSI SOLUTIONS, Inc. Copyright © 2010, LSI SOLUTIONS®. All Rights Reserved.



Symbol Glossary: www.lsisolutions.com/symbols



LSI SOLUTIONS®
7796 Victor-Mendon Road
Victor, New York 14564 U.S.A.
Phone: 585.869.6600
Customer Service: 866.575.3493
Technical Support: 866.428.9092
Fax: 585.742.8086
www.lsisolutions.com

MADE IN THE USA

This Product Comes
with our LSI SOLUTIONS®
Perfect Performance Policy®
Call us at 866.575.3493 any time.

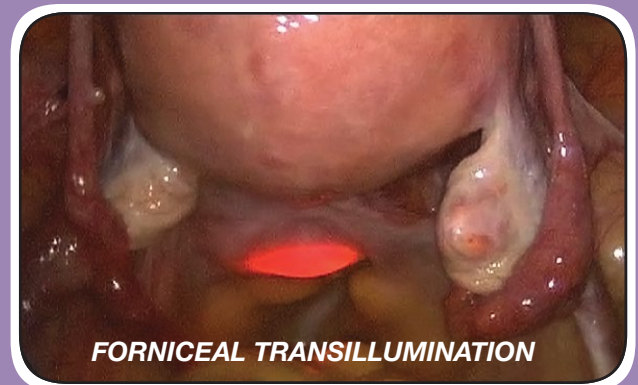

FORNICEAL TRANSILLUMINATION

P/N 110010G, 10 April 24