

10mm RD180® DEVICE TECHNOLOGY GUIDE

READ THIS PRODUCT INSERT THOROUGHLY BEFORE USE

FIG. 1

10mm RD180® - THE RUNNING DEVICE®

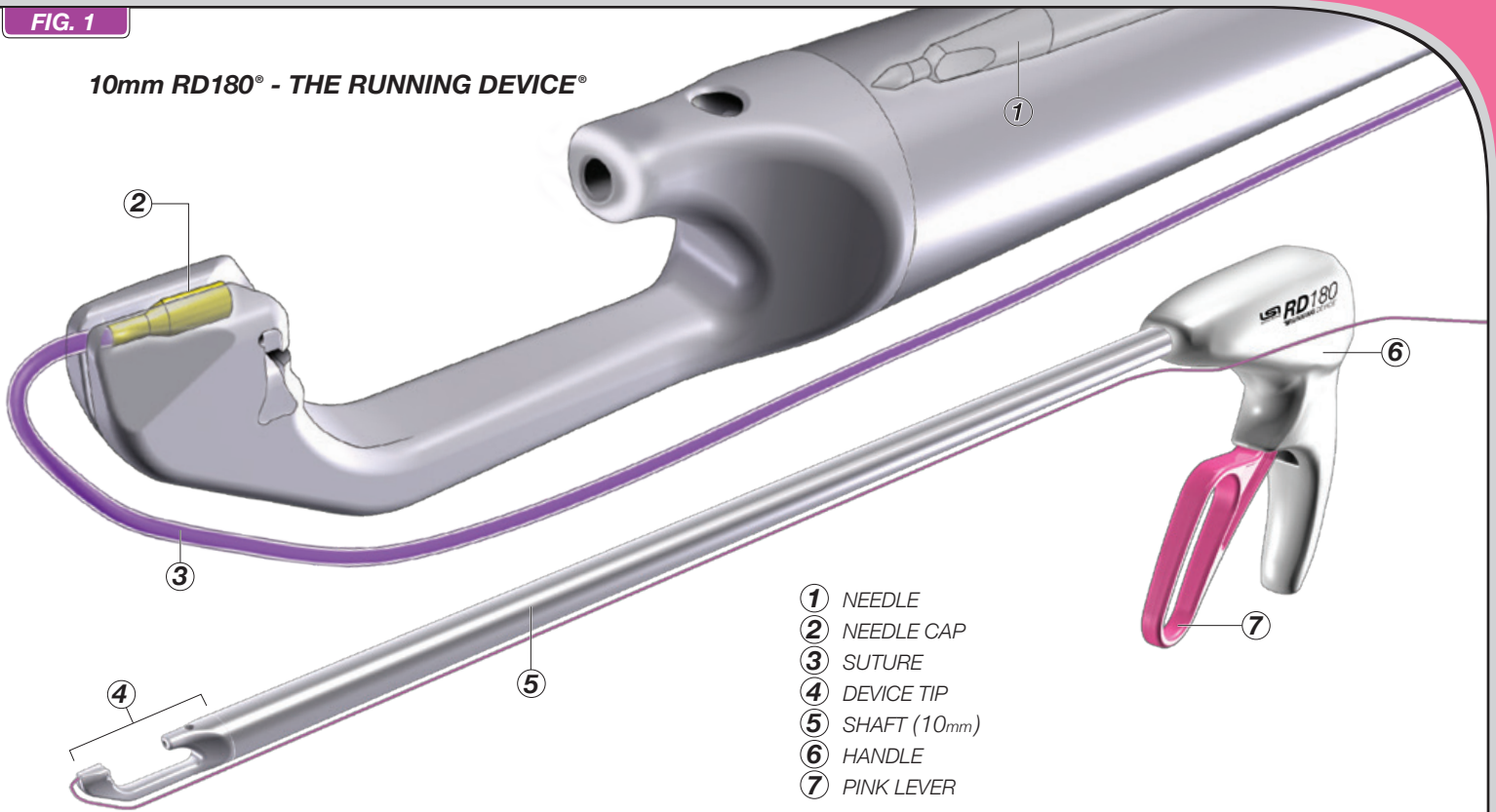

10mm RD180® - THE RUNNING DEVICE® DESCRIPTION

Each sterile package contains one (1) 10mm RD180® suturing device (33cm long shaft) (FIG. 1). 10mm RD180® DEVICE is used for the placement of surgical suture as supplied. A short length of modified surgical stainless steel tubing, called a needle cap ②, is attached to one end of the suture ③. The needle cap is loaded into the needle cap compartment in the jaw of the device tip ④. Suture placement and suture rearm (FIG. 2) are each achieved by sequentially squeezing and releasing the pink lever ⑦. During suture placement, the initial squeeze of the pink lever advances the retracted needle forward through the selected tissue placed in the jaw of the device tip; the full squeeze advances the needle into the needle cap held in the device tip's distal end. Release of the pink lever retracts the needle, which pulls the now engaged needle cap and suture back through the tissue. Next, with the device tip oriented for suture rearm, a second squeeze of the pink lever advances the needle with its now engaged needle cap and suture forward through the empty jaw into the device tip's distal end, where a latch feature retains the needle cap and suture. Release of the lever returns the needle alone back to its retracted position in the distal shaft ready for repeat suture placement.

INDICATIONS

The RD180® suturing device is indicated for use in the approximation of soft tissue and prosthetic materials.

SOLUTIONS®

SUTURE PLACEMENT

SUTURE REARM

FIG. 2

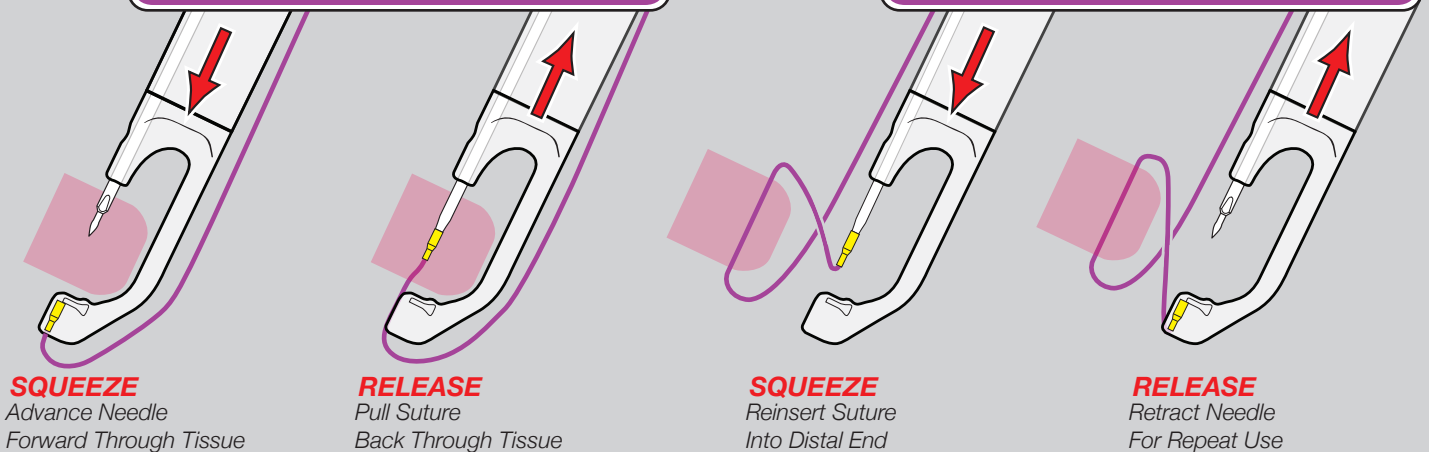

RD[®] QUICK LOAD[®] SUTURE

FIG. 3

RD[®] QUICK LOAD[®] SUTURE

- ① SUTURE TRAY
- ② SUTURE RELEASE FEATURE
- ③ NEEDLE CAP
- ④ SUTURE
- ⑤ SUTURE TUBE

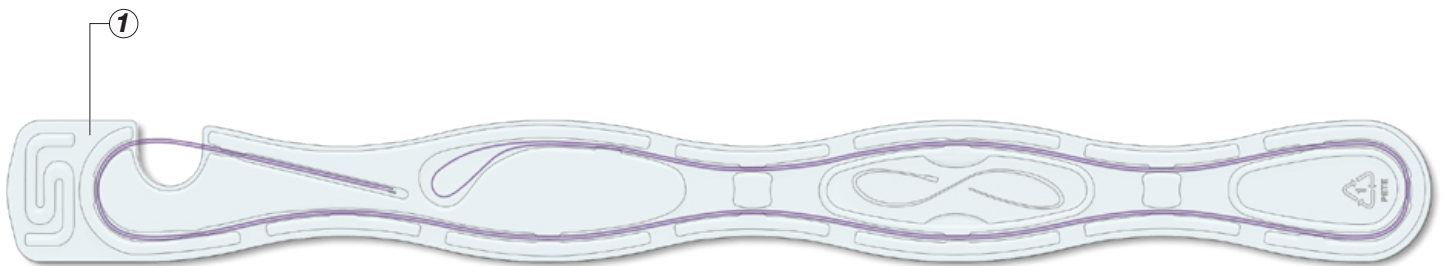
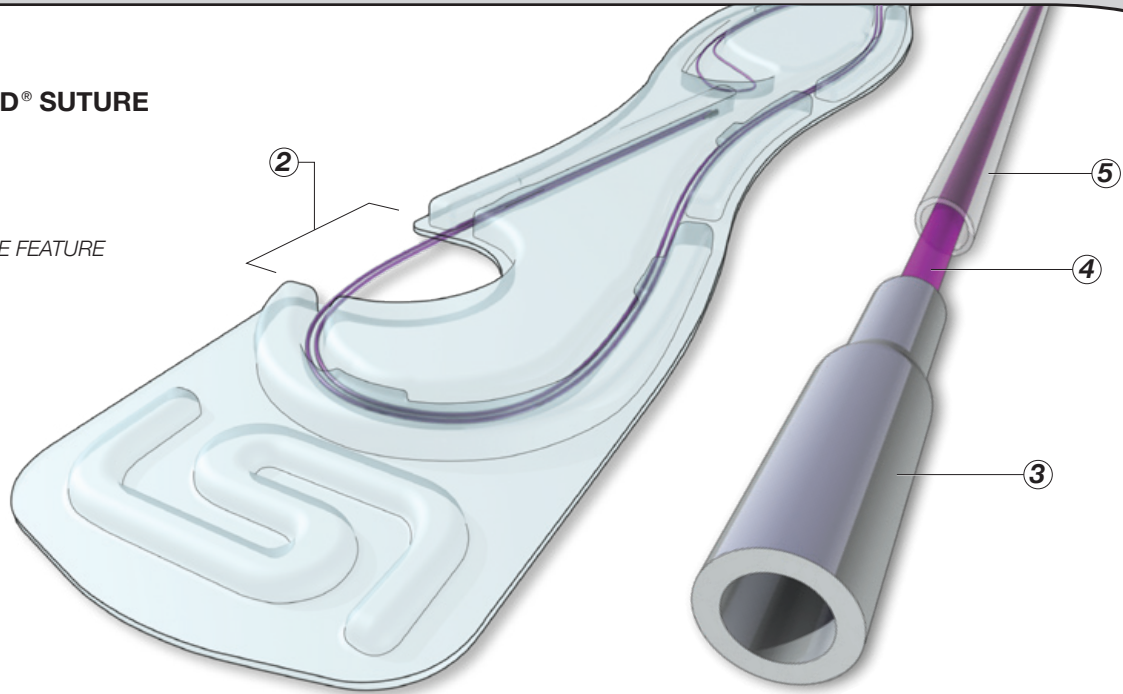

DESCRIPTION

Each LSI SOLUTIONS[®] RD[®] QUICK LOAD[®] sterile suture is held in a customized tray (1) with suture release feature (2), designed to enable the rapid, easy and reliable loading of suture into RD[®] and RD180[®] devices. RD[®] QUICK LOAD[®] products are available in excellent quality non-absorbable or absorbable suture materials in both braided and monofilament configurations (FIG. 10). A short length of modified surgical stainless steel tubing, called a needle cap (3), is attached to the end of the suture (4). The RD[®] QUICK LOAD[®] suture also includes a detachable clear suture tube (5) to keep the suture from tangling. Each sterile RD[®] QUICK LOAD[®] suture is individually packaged for single patient use.

INDICATIONS

RD[®] QUICK LOAD[®] suture is indicated for use in the approximation of soft tissue and prosthetic materials.

CAUTION:

To avoid accidental needle exposure, **DO NOT** squeeze lever during suture loading.

ACTIONS

To facilitate the placement of multiple stitches of the same suture (i.e., “running” or tying the suture) without needing to manually rearm each needle cap, the needle cap rearming mechanism of the 10mm *RD180*[®] *DEVICE* enables the remote return and rearming of the needle cap back into the needle cap compartment. The operator presents an appropriate tissue structure into the gap of the metal jaw in the device tip of the 10mm *RD180*[®] *DEVICE*. During suture placement, the pink lever is squeezed to advance the retracted needle from the shaft of the device through the tissue in the jaw and into the needle cap. The distal contoured end of the 10mm *RD180*[®] *DEVICE* needle engages and captures the needle cap with its attached suture. Releasing the pink lever retracts the needle with attached needle cap and suture back through the tissue. For suture rearm, the distal tip is then moved away from any tissue structures to clear the jaw for needle cap rearming. The pink lever is again fully squeezed to advance the needle, needle cap and suture forward through the empty jaw toward the needle cap compartment at the most distal end of the device tip. Care must be taken to ensure the suture crimped to the distal end of the needle cap is oriented to permit the suture to freely pass through the suture track opening in the needle cap compartment. Jamming misoriented suture into the needle cap compartment can damage suture and device. With the pink lever fully squeezed and the needle with its attached needle cap and suture completely forward, the now rotated needle will permit the needle cap rearm latch to engage the face of the needle cap and cause its release from the needle. With the first tissue suture placement complete, the needle cap rearm into the needle cap compartment, and the pink lever back in its starting location, the 10mm *RD180*[®] *DEVICE* is ready for another tissue bite. This sequence can be repeated for up to 12 bites (or 12 complete functional cycles) with a single *RD*[®] *QUICK LOAD*[®] suture and with up to 12 *RD*[®] *QUICK LOAD*[®] sutures per device.

CONTRAINDICATIONS

- Minimally invasive surgical procedures should only be performed by physicians having adequate training and familiarity with endoscopic techniques. In addition, medical literature should be consulted relative to techniques, complications and hazards prior to the performance of minimally invasive procedures.
- The 10mm *RD180*[®] *DEVICE* is not intended to be used with any suture other than *RD*[®] *QUICK LOAD*[®] suture.
- Do not use this suture under conditions in which excessive suture tension can lead to tissue damage. For example, do not use *RD*[®] *QUICK LOAD*[®] suture through an excessively narrow, restrictive or defective cannula access port, which could significantly impair easy and smooth passage of the suture or device.

WARNINGS

- Federal (U.S.A.) law restricts this device to sale, distribution and use by, or on, the order of a physician.
- Do not resterilize.** The performance of the 10mm *RD180*[®] *DEVICE* after cleaning or other reprocessing has not been verified and is not supported by LSI SOLUTIONS[®].
- Discard open (unsealed), unused, expired or damaged devices or devices in damaged primary packaging.
- As with any foreign body, prolonged contact of any suture with salt solutions, such as those found in the urinary or biliary tracts, may result in calculus formation.
- Users should be familiar with surgical procedures and techniques involving suture before employing the 10mm *RD180*[®] *DEVICE* for wound closure, as the risk of wound dehiscence may vary with the site of application.
- Acceptable surgical practice must be followed with respect to drainage and closure of infected or contaminated wounds.
- Redundant, cut-away suture remnants, used needle caps, and 10mm *RD180*[®] *devices*, along with packaging, must be inspected, handled and disposed of consistent with standard, accepted medical device disposal procedures.
- The 10mm *RD180*[®] *DEVICE* is indicated for use in the approximation of soft tissue. Applications other than for soft tissue closure, or to anchor another device, can result in failure to pick up suture or in damage to the device making it unsuitable for continued use.
- Never drive the needle into suture, bone, dense ligamentous tissue, or other instruments.
- RD*[®] *QUICK LOAD*[®] suture is not for use in cardiovascular and neurological procedures.

PRECAUTIONS

- Check for hemostasis or leakage where appropriate.
- Minimally invasive instruments may vary in diameter from manufacturer to manufacturer. Before endoscopic instruments and accessories from different manufacturers are employed together in a procedure, verify compatibility and ensure electrical isolation or grounding are not compromised.
- Care must be taken when inserting this or any device through a cannula to avoid advancing the device incorrectly (e.g., too far or too quickly). Device insertion should be easy, smooth and controlled to minimize the risks of trauma to the patient or damage to the device.
- Always assure insufflation, camera position and device tip location are viewed under direct visualization before advancing the needle.
- Ensure obstructions do not interfere with the movement of the needle of 10mm *RD180*[®] *DEVICE*.
- In handling the 10mm *RD180*[®] *DEVICE*, care should be taken to avoid jamming the suture into the needle cap compartment and damage to the needle.
- Avoid damage to the needle, suture or needle caps due to direct application of surgical instruments, like forceps, needle holders, clamps, etc.
- Adequate knot security requires accurate completion of accepted surgical techniques for constructing surgically tied knots or the use of the *TK*[®] *Ti-KNOT*[®] *DEVICE* and *TK*[®] *QUICK LOAD*[®] unit as warranted by surgical circumstances and the experience of the surgeon.
- Before loading the 10mm *RD180*[®] *DEVICE* with another *RD*[®] *QUICK LOAD*[®] suture, assure the remaining suture tail and needle cap from the previous load has been removed from the needle. Failure to appropriately remove used needle caps from the needle can result in damage to the device, including intracorporeal or extracorporeal fracturing off the tip of the needle, making it unsuitable for continued use.
- After each loading and re-loading of a new suture into this device, squeeze the pink lever to drive the needle forward into the new needle cap loaded into the needle cap compartment. If the needle cap is picked-up by the needle, then squeeze the lever again to rearm the needle cap and suture back behind the latch. If the needle rotation is oriented to rearm the needle cap, then the needle will retract back without the needle cap and suture attached. This “cycling” (*FIG. 4, Step 5*) of the needle helps ensure that the previous needle cap was properly removed, the new needle cap is installed properly and the operator receives the device with its needle oriented to pick-up the needle cap on its first needle advancement. If the previous needle cap was not properly removed from the needle prior to reloading the device, the needle will not fully advance into the new needle cap in the needle cap compartment. Driving a needle with a needle cap into another needle cap can lead to the breaking off of the tip of the needle.
- Do not use the 10mm *RD180*[®] *DEVICE* to dissect or aggressively manipulate tissue structures.
- Verify the needle cap is still retained within the needle cap compartment and the device has not been damaged or deformed before attempting to place a stitch.
- Do not manipulate the device at any time with the pink lever partially actuated. This may expose sharp surfaces that can cause trauma to the patient, the device operator or other staff, or damage the device.
- To avoid inadvertent suture damage, ensure the needle cap always enters the needle cap compartment with its suture oriented to freely pass through the needle cap compartment’s suture track. Do not use damaged or expired suture.
- Ensure the advancing needle targets and enters the needle cap compartment. For example, during the suture placement avoid using an extended needle to manipulate or lift tissue because such an action can cause the needle to deviate from its targeted course toward the needle cap compartment. A needle tip, not entering the needle cap compartment properly, can strike the distal tip of the device and lead to undesired outcomes, including needle tip fracture. For another example, during suture rearm, avoid applying tension to the suture from the needle cap on the needle. Tension on the suture can cause the needle to deviate off target and lead to the needle cap possibly striking the distal tip, which can cause needle tip fracture.

ADVERSE REACTIONS

Adverse effects associated with the use of suture include wound dehiscence, failure of adequate wound support in closure sites where expansion, stretching or distension occur, enhanced bacterial infectivity, minimal acute inflammatory tissue reaction, localized irritation when skin sutures are left in place for greater than 7 days, calculi formation in urinary and biliary tracts when prolonged contact with salt solutions such as urine and bile occurs, and pain, edema and erythema.

LOADING SUTURE

CAUTION: To avoid accidental needle exposure, **DO NOT** squeeze lever during suture loading.

FIG. 4

1 REMOVE Suture And Suture Tube From Tray

REMOVE suture and suture tube from tray by grasping suture tube at suture release feature and pulling suture tube completely out of tray.

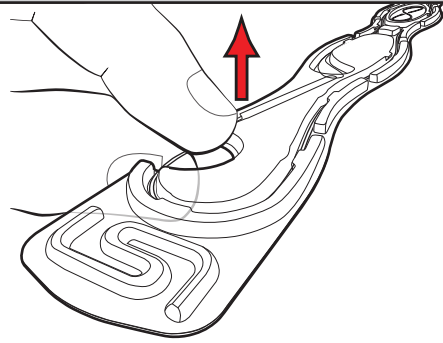

2 INSERT Suture Into Suture Track

INSERT suture into the suture track as shown; may require pulling needle cap and suture further out of suture tube.

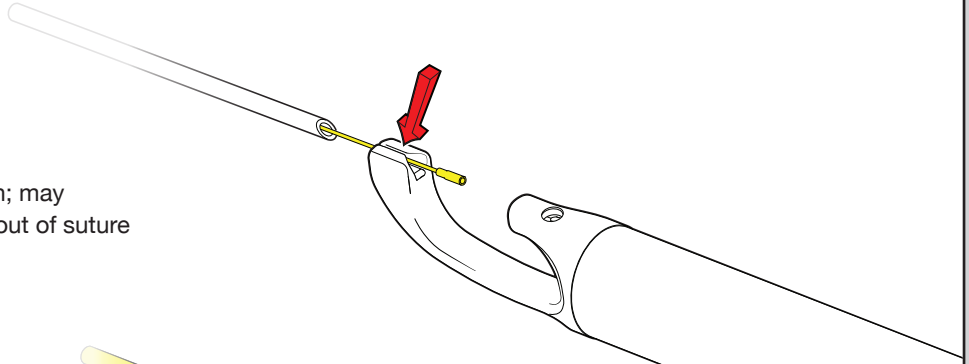

3 PULL Needle Cap Into Compartment

PULL suture to seat needle cap into needle cap compartment in the distal end of the device tip. It may help to guide the needle cap with a finger. Make sure needle cap is fully seated behind latch.

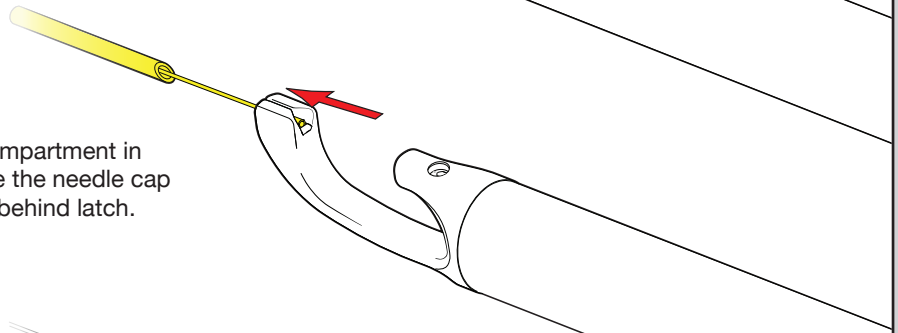

4 REMOVE Suture Tube

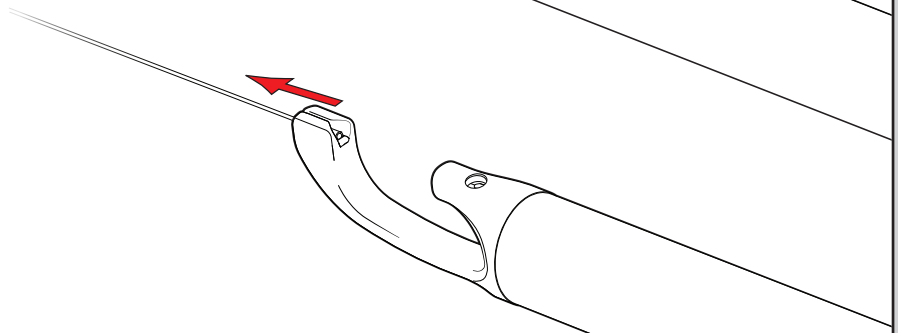

5 FIRE & REARM Orient Suture As Shown, Squeeze And Release Lever To Ensure Suture Is Ready In Distal End Of Device Tip

FIRE & REARM to ensure suture is loaded properly. To avoid jamming the needle cap into the needle cap compartment, orient the suture directly away from the jaw as shown. Squeeze the lever to advance the needle through the jaw and into the newly loaded needle cap. Release the lever to pick up and retract the needle cap with attached suture back on the needle into the shaft. While continuing to orient the suture as shown, squeeze the lever to advance the needle, needle cap, and suture forward through the jaw to rearm the needle cap into its compartment. Release the lever again and retract back the now-empty needle, leaving the needle cap and suture ready for patient use.

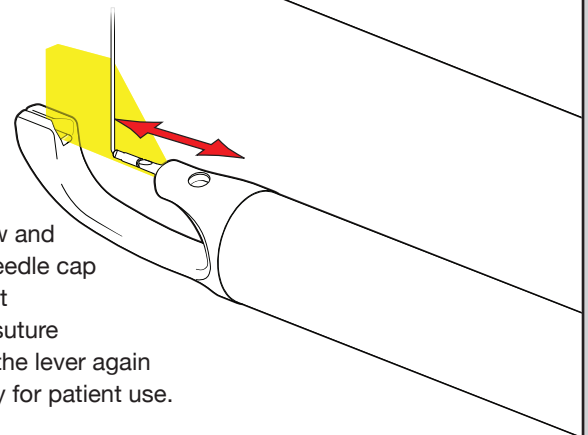

UNLOADING SUTURE

UNLOADING NEEDLE CAP AND REMAINING SUTURE FROM 10mm RD180® DEVICE

The Auto-release Technique, as illustrated below (FIG. 5) is an easy method for removal of used needle caps from the needle prior to reloading a suturing device. This technique automatically removes the suture and needle cap from the needle by simply pulling the lever fully forward.

FIG. 5



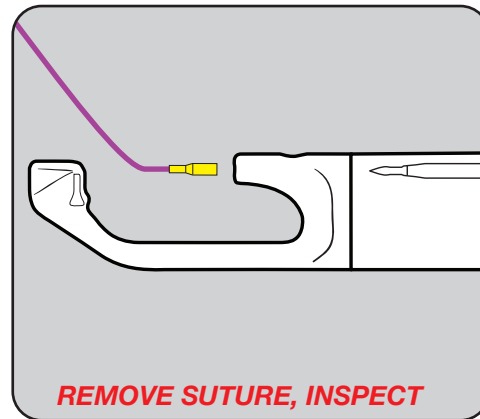
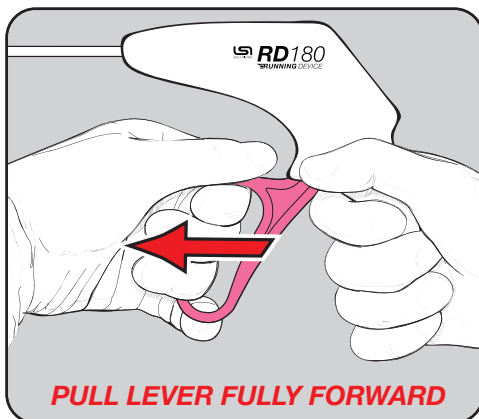
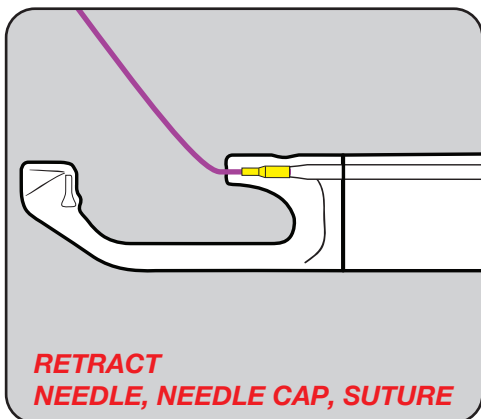



AUTO-RELEASE Technique *Retract Suture Back. Pull Lever Fully Forward. Remove Suture With Needle Cap.*

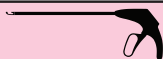

This unloading technique requires that the needle with its engaged needle cap and suture must first be retracted back into the distal end of the device shaft. If they are not, simply squeeze and release the pink lever to pick up and retract the needle cap, suture, and needle. Once the needle cap, suture, and needle are retracted into the shaft, pull the pink lever fully forward to automatically remove the needle cap and suture off of the needle. Inspect and discard the used needle cap and suture.

FIG. 6 PRODUCT ORDERING

SUPPLIED: STERILE

	REORDER	PRODUCT	DESCRIPTION
 x 6	REF 021330	10mm RD180® DEVICE	Box of 6 Kits (1 Device per Kit)
 x 12	REF 020979	RD® QUICK LOAD® SURGICAL SUTURE 2-0 Polyester, Non-Absorbable, 53", Green, Braided	Box of 12 Sutures (1 Suture per Pouch)
 x 12	REF 021010	RD® QUICK LOAD® SURGICAL SUTURE 0 Polyester, Non-Absorbable, 53", Green, Braided	Box of 12 Sutures (1 Suture per Pouch)
 x 12	REF 020989	RD® QUICK LOAD® SURGICAL SUTURE 2-0 Polypropylene, Non-Absorbable, 53", Blue, Monofilament	Box of 12 Sutures (1 Suture per Pouch)
 x 12	REF 021025	RD® QUICK LOAD® SURGICAL SUTURE 2-0 Strongorb®, Absorbable, 53", Purple, Braided	Box of 12 Sutures (1 Suture per Pouch)
 x 12	REF 021030	RD® QUICK LOAD® SURGICAL SUTURE 2-0 Monoglide®, Absorbable, 53", Purple, Braided	Box of 12 Sutures (1 Suture per Pouch)
 x 12	REF 021506	RD® QUICK LOAD® SURGICAL SUTURE 0 Monoglide®, Absorbable, 53", Purple, Braided	Box of 12 Sutures (1 Suture per Pouch)

10mm RD180[®] DEVICE TECHNIQUE PEARLS

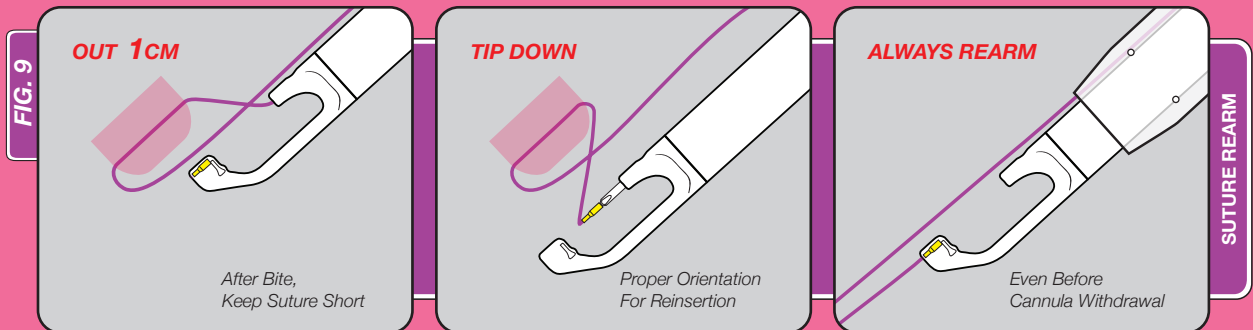
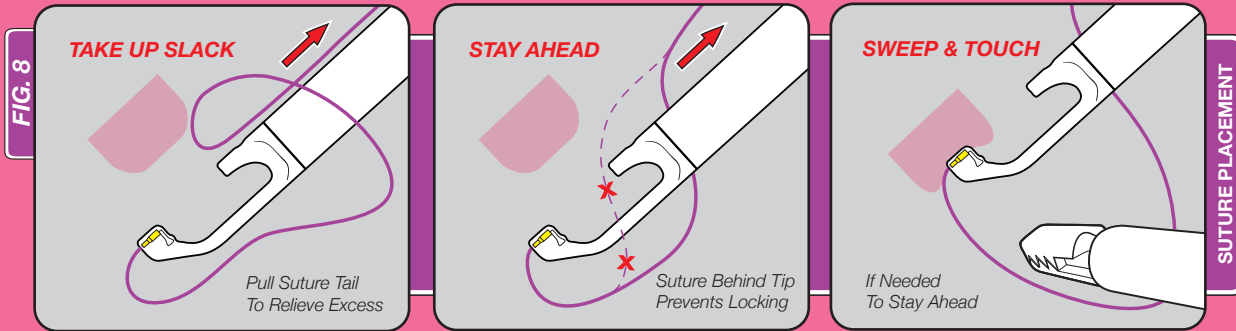
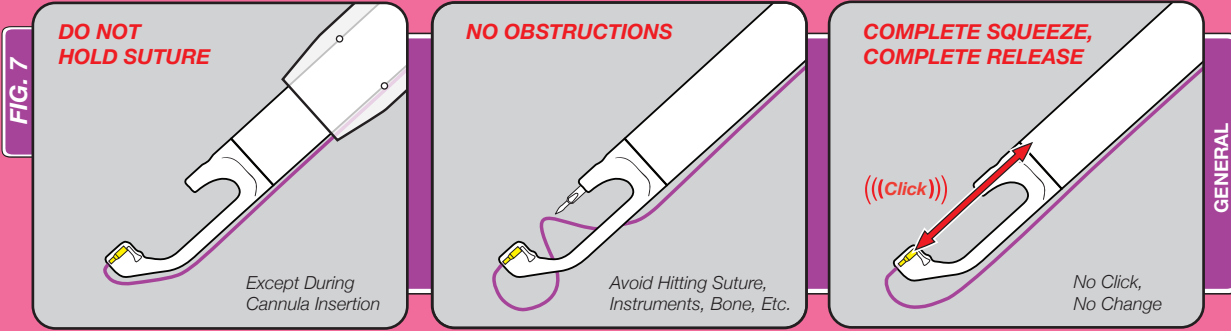

LSI SOLUTIONS[®]

Patents: www.lsisolutions.com/patents

The LSI logo, LSI SOLUTIONS, RD 180, The Running Device, RD, StrongSorb, MonoGlide, TK, Ti-Knot, Quick Load, and Perfect Performance Policy are trademarks and registered trademarks of LSI Solutions, Inc. Copyright © 2010, LSI SOLUTIONS[®]. All Rights Reserved.



Symbol Glossary: www.lsisolutions.com/symbols

LSI SOLUTIONS[®]
 7796 Victor-Mendon Road
 Victor, New York 14564 U.S.A.
 Phone: 585.869.6600
 Customer Service: 866.575.3493
 Technical Support: 866.428.9092
 Fax: 585.742.8086
www.lsisolutions.com

MADE IN THE USA

This Product Comes
 with our LSI SOLUTIONS[®]
Perfect Performance Policy[®]
 Call us at 866.575.3493 any time.